

## OhmCraft Resistor Pulse Withstanding Capability

W. M. Mathias

---

Chip resistors with capability to withstand high voltage pulse stresses

### Introduction

Many electronic systems must be designed to operate and survive in the presence of electrical pulses and transient overloads. These pulses present a transient high energy shock to the resistor, and/or a high voltage, high energy excursion. This requirement ranges from input protection network needs to internal failsafe overload and shutdown circuitry in diverse application such as power supplies, telecommunication networks, and AEDs (Automated External Defibrillators). Central elements in these designs are chip resistors with the capability to survive and remain in tolerance in the presence of these harsh conditions. Until recently, chip resistors did not have the capability to withstand extreme abuse, thus the designer was forced to utilize leaded devices or multiple chip resistors in series to provide this protection. Due to advances in construction techniques, chip resistors with substantial pulse withstanding characteristics are now available in a wide range of sizes, tolerances and values.

### Basis of Performance

Resistors are traditionally manufactured using a variety of technologies including thick film, thin film, wirewound, metal film, and foil. Each of these resistor technologies fills a particular application niche. Thick film materials, applied in the construction of chip resistors, are well suited for pulse withstanding applications.

The typical method of construction of thick film resistors is to screen-print the thick film resistive element on to a substrate. In allied operations including glass overcoat, wrap around conductors, laser trimming, and singulation are performed yielding finished chip resistors. OhmCraft pulse withstanding resistors are unique in that in place of screen printing; the resistive element is directly produced using a MicroPen direct writing system as seen in the photograph.

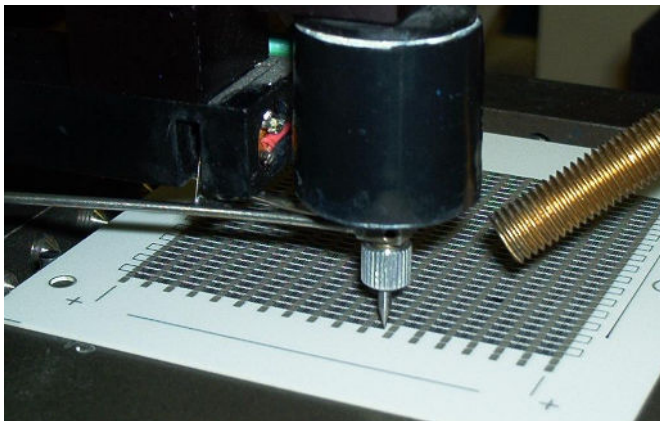

**Writing 1206 chip resistors:**  
For this production lot, the resistor element is a 4 mil wide line.

## Pulse Voltage Capability

OhmCraft's direct writing technique is the basis of OhmCraft Fine Film™ thick film processing technique. Fine Film™ technology is critical to the robust performance of pulse withstanding resistors. The major benefit is direct writing's ability to write narrow lines and narrow spaces, thus enabling long serpentine, high square count designs. To illustrate this point, the drawings on the left are conventional thick film resistors and the one on the right is an OhmCraft Fine Film™ chip resistor.

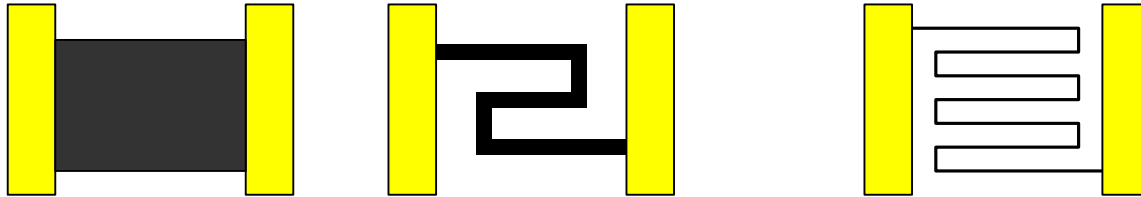

**Conventional thick film  
Block style**

**Course serpentine**

**OhmCraft's Fine Film™  
Fine Line serpentine**

An electrical pulse can damage and or degrade the actual resistive element (the feature shown in black in the above drawings) when the voltage per unit length exceeds the design limit of the base thick film resistive material. This thick film material constraint is defined as a threshold of 'x' volts per millimeter of resistor element length. A straight forward way of improving the pulse withstanding capability of a resistor is to simply increase the total length of the resistive element. This is the basic principle behind OhmCraft's Fine Film™ pulse withstanding chip resistors.

For example, the block style resistor, shown in the drawing on the left above, has a relatively low total resistor element length, thus will have a modest working voltage and pulse capability specification. Most commodity type thick film resistors are based on this style design, and thus are not particularly suited for, or capable of, reliable operation in pulse withstanding applications. The middle drawing above shows the resistive element of a conventionally manufactured course serpentine chip resistor. The total element length is longer and will show improved pulse withstanding capability. However, the drawing on the right that represents an OhmCraft Fine Film™ pulse resistor, with a long relatively serpentine resistive element is designed for maximum pulse voltage capability.

Now let's review a few real application examples.

### Case #1

A customer is using a 26.1Kohm, 1% tolerance, 2010 chip resistor in an RF filter circuit. In normal operation, this resistor must withstand 1.5KV exponential pulses with a time constant of approximately 4 milliseconds. This customer selected an OhmCraft Fine Film™ chip resistor because competitive chip resistors are not capable of handling these functional requirements. The inherent high voltage capability coupled with the superior energy absorption of the OhmCraft resistor proved to be the design solution for this critical application. In this case, the energy absorbed and peak power is:

$$\begin{aligned} E &= \frac{1}{2} C \cdot V^2 \\ E &= \frac{1}{2} (0.12 \cdot 10^{-6}) \cdot 1500^2 \\ E &= 0.135 \text{ Joules} \end{aligned}$$

$$\begin{aligned} \text{Peak Power} &= V^2 / R \\ \text{Peak Power} &= (1500)^2 / (26100) \\ \text{Peak Power} &= 86 \text{ Watts} \end{aligned}$$

## Case #2

A customer is using a 30M ohm, 1% tolerance, 1206 chip resistor in an automatic heart defibrillator. In normal operation, this resistor must withstand 4KV exponential pulses with a time constant of approximately 1.2 milliseconds. In this application, the pulse energy dissipated is higher than Case #1 above. The reliable performance of the resistor is a function of its high voltage handling capability, coupled with its ability to absorb the pulse energy.

$$E = \frac{1}{2} C \cdot V^2$$

$$E = \frac{1}{2} (0.1 \cdot 10^{-6}) \cdot 4000^2$$

$$E = 0.8 \text{ Joules}$$

$$\text{Peak Power} = V^2 / R$$

$$\text{Peak Power} = (4000)^2 / (30 \cdot 10^6)$$

$$\text{Peak Power} = 0.53 \text{ Watts}$$

Note: The continuous working voltage rating on this 1206 part is 1000 volts.

## Case #3

A customer is using a 100Kohm, 10% tolerance, 2512 chip resistor in an automatic heart defibrillator. The continuous voltage rating on this 2512 part is 2500 volts. In normal operation, this resistor must withstand 5KV exponential pulses with a time constant of approximately 3.5 milliseconds. In this situation, the pulse energy dissipated is shown below. The overall performance of the resistor is a function of its high voltage handling capability, coupled with its ability to absorb the pulse energy.

$$E = \frac{1}{2} C \cdot V^2$$

$$E = \frac{1}{2} (0.05 \cdot 10^{-6}) \cdot 5000^2$$

$$E = 0.625 \text{ Joules}$$

$$\text{Peak Power} = V^2 / R$$

$$\text{Peak Power} = (5000)^2 / (10 \cdot 10^4)$$

$$\text{Peak Power} = 250 \text{ Watts}$$

Note: The application required the resistor to absorb the 0.36 Joules of energy associated with a 5000 volt pulse. The OhmCraft resistor was successfully tested to a peak voltage over 6000 volts and 2 joules of energy.

## Test Procedure

Pulse capability tests were performing using a basic test fixture:

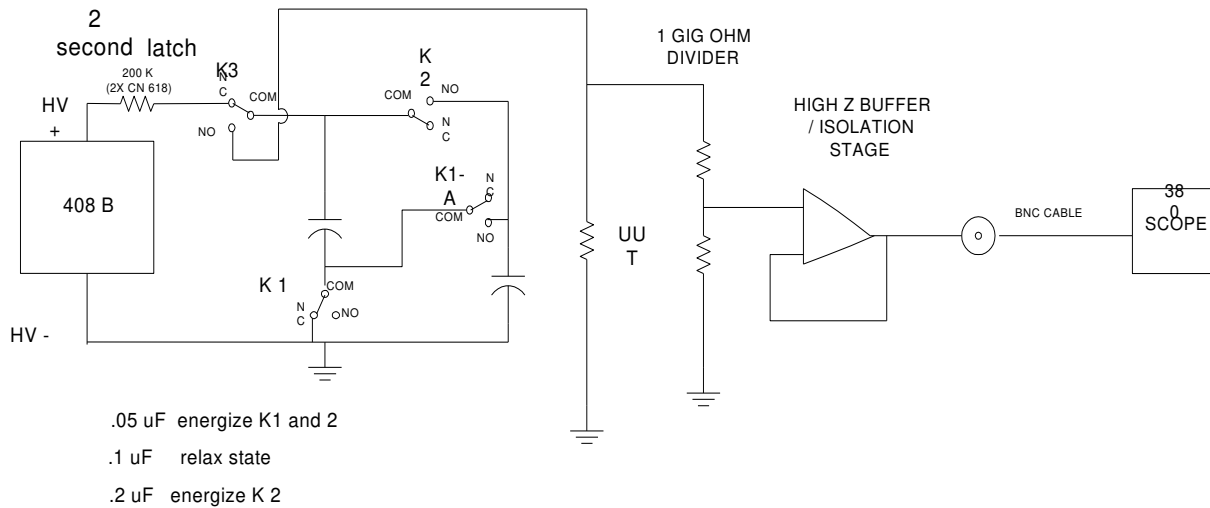

### Basic test fixture for pulse voltage capability

We tested chip resistors ranging from 8K to 50M ohm in value, and used <1% delta R as the acceptance criteria. A typical sample pulse waveform is shown below. The scope trace 1 example is a 1206 case size, 31.5MΩ resistor. Scope trace 2 is a 2512, 100KΩ resistor.

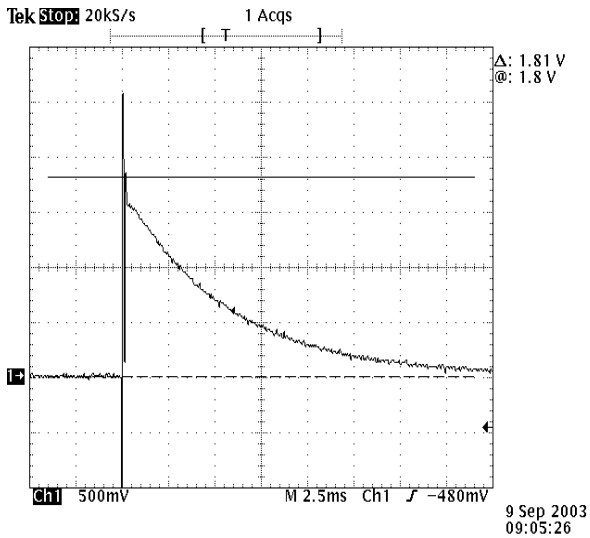

Scope Trace 1: 1206 chip resistor

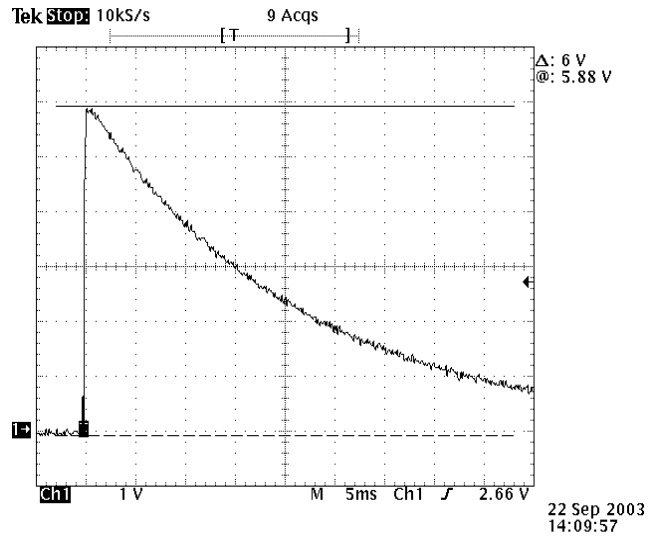

Scope Trace 2: 2512 chip resistor

The sample waveform shown on the left is approximately 2700 volts peak with a 3.7 ms fall time. The energy dissipated in this case was about 0.5 joules. OhmCraft determined that the maximum pulse voltage, in air, is limited to approximately 4100 volts for the 1206 case size. For the 1206, arc over (between contacts, in air) occurs at 4500 to 4900 volts.

The sample waveform shown on the right is approximately 6000 volts peak with a 9.0 ms fall time. The energy dissipated in this case was about 2 joules. OhmCraft determined that the maximum pulse voltage, in air, is limited to approximately 6000 volts for the 2512 case size. For the 2512, arc over (between contacts, in air) occurs at approximately 6500 volts.

The significant energy absorption capability of the OhmCraft Fine Film™ is only part of the story. The inherent design and manufacturing process also enables OhmCraft Fine Film™ chip resistors to have superior high voltage performance.

### **Pulse voltage Capability**

The basis of the pulse voltage capability *and* maximum voltage capability lies in the resistive element design and the specific choice of thick film ink utilized in the resistor. The performance characteristics of OhmCraft Fine Film™ resistors are determined by the combination of the total element length, the element width and the choice of thick film material. To explain how this applies to OhmCraft Fine Film™ chip resistors, a straight forward example is in order.

For some designs, the maximum element length for an OhmCraft Fine Film™ 2512 chip resistor can exceed 100 millimeters. For some designs, the thick film ink utilized is capable of operating at 400 volts per millimeter, thus the total element is capable of continuous, safe operation at 40,000 volts. However, one always must be mindful of the critical resistance value. The critical resistance value is:

- The continuous power rating for the 2512 is 2 watts.
- Critical resistance value, in ohms = (operating voltage)<sup>2</sup> / power (watts)

Substituting:

$$800M\Omega = (40000)^2 / 2$$

Thus the ohmic value for this 2512 must be over 800MΩ. The point is, OhmCraft Fine Film™ chip resistors can be designed to reliability operate at extremely high voltages if that is an application requirement. Obviously, at these high voltages, the resistor must be coated with an appropriate potting compound, or operated in oil, as contact arc over will occur if operated in air. If one does a similar analysis of an OhmCraft Fine Film™ 1206 chip resistor, the maximum voltage capability extends beyond 25,000 volts.

For the case studies presented in this application note, all resistors were tested in air at typical electronic shop temperatures and humidity levels. The peak pulse voltage performance is remarkable, as is the total pulse energy absorption capability. This capability is a direct result of the basic resistor element design criteria. The following graphs compare peak voltage performance of an OhmCraft Fine Film™ chip resistors with published performance of competitive product.

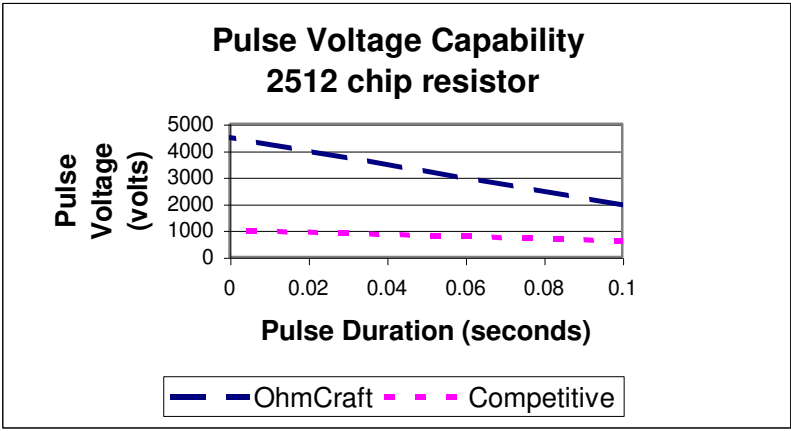
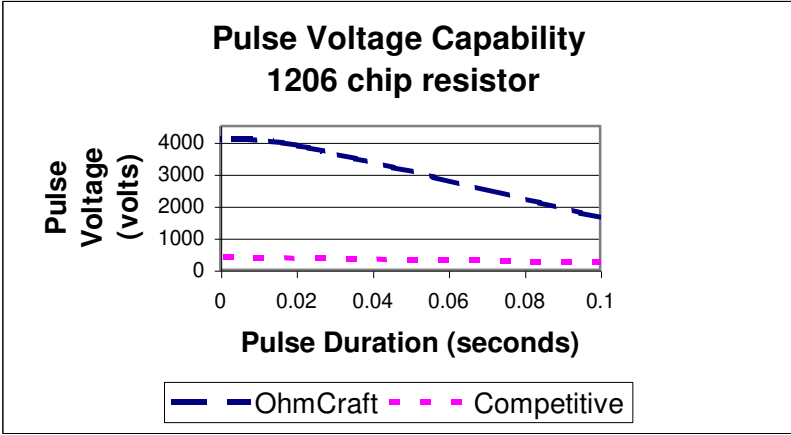

**Conclusion**

OhmCraft's fine line patterning is the basis of our Fine Film™ thick film processing technique. Fine Film™ technology is critical to the robust performance of the pulse withstanding resistors. The examples presented demonstrate OhmCraft's Fine Film™ pulse withstanding chip resistors reliability and consistent ability to absorb energy without failure. OhmCraft's Fine Film™ pulse withstanding chip resistors reliably and consistently absorb up to 2 Joules of energy without failure (2512 case size). Equally important, the maximum peak voltage capability is *at least* 2 times the working voltage and for many ohmic values exceeds 10 times the working voltage. OhmCraft's Fine Film™ pulse withstanding chip resistors demonstrate superior reliability, durability and performance, especially in high voltage pulse applications in medical, telecommunication, and power supply applications.