

# **BD027-14E**

## **Low-Voltage Nanopower Digital Switch for Medical Devices**

### **Key Features**

- Low Voltage Operation to 0.9 V
- Power Consumption 45 nW Maximum at 0.9 V
- Digital Switch Output
- Precise Detection of Low Magnetic Fields
- Ultraminiature Package

### **Description**

BD027-14E Series sensors are Giant Magnetoresistive (GMR) Digital Switch devices designed to run at low voltages and extremely low currents. The devices are manufactured with NVE's patented spintronic GMR technology for unmatched miniaturization, sensitivity, precision, and low power.

The output is configured as a magnetic "switch" where the output turns on when the magnetic field is applied, and turns off when the field is removed. The IC is available for continuous duty operation, or internally duty cycled at approximately 0.1% to conserve power. An integrated latch ensures the output is available continuously in duty-cycled mode. The part is available in NVE's new ULLGA leadless package measuring just 1.1 mm x 1.1 mm x 0.4 mm.

The BD027-14E parts are ideal for single battery-powered implantable medical devices. The applied magnetic field can be of either polarity, and the part consumes less than 1 microwatt of power. The magnetic operate point is extremely stable over supply voltage and temperature variations. The output is current-sinking, and can sink up to 100 microamps.

The product consists of an approximately 0.6 mm x 0.6 mm die containing a GMR sensor element, CMOS signal processing circuitry to convert the analog sensor element output to a digital output, and an oscillator and timing circuit for duty cycling. The plastic package is ultra-small, ultra-low profile, surface mount, lead-free, and RoHS compliant. Bare die are also available for extremely space-critical applications.

Versions of this part with different magnetic characteristics are available. Please contact NVE for details.

**Functional Block Diagram**

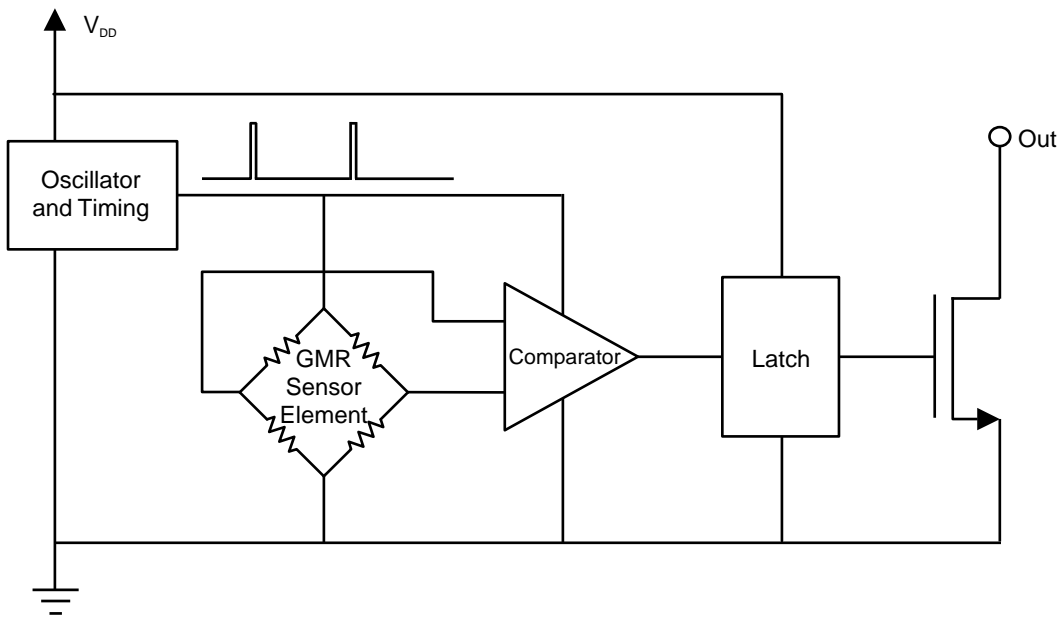

**Operation**

The direction of magnetic field sensitivity is planar to the package. As the field varies in intensity, the digital output will turn on and off. The user must provide a pull-up resistor on the output terminal.

**Sensor Activation With a Permanent Magnet**

The diagrams below show two permanent magnet orientations that will activate the sensor in the direction of sensitivity (planar to the package):

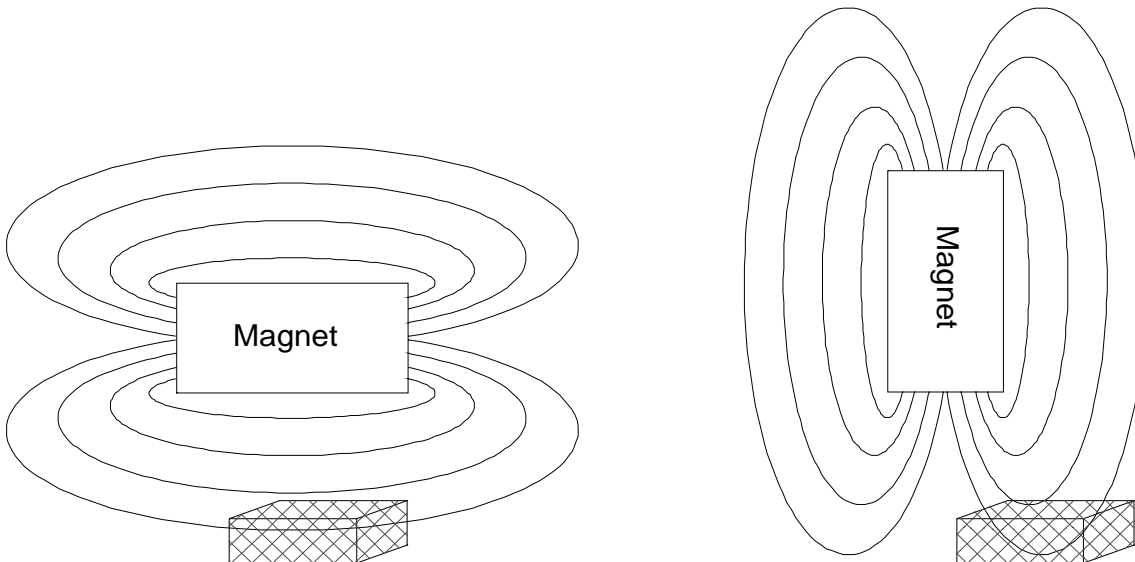

## Electrical and Magnetic Specifications

(specifications valid over all operating voltage and temperature ranges):

Parameter	Min.	Typ.	Max.	Units
Magnetic Operate Point	11	15	19	Oersteds <sup>(1)</sup>
Magnetic Release Point	4.5			Oersteds <sup>(1)</sup>
Hysteresis	0.25		6.5	Oersteds <sup>(1)</sup>
Operating Voltage ( $V_{DD}$ ) <sup>(3)</sup>	0.9	1.25	2.4	Volts
Quiescent Current at 0.9 V		0.032	0.060	$\mu$ A
Quiescent Current at 1.4 V		0.095	0.150	$\mu$ A
Quiescent Current at 2.4 V		0.460	0.650	$\mu$ A
Peak Current During Sensor Sampling (1.4 V)		35	55	$\mu$ A
Output Drive Current	100			$\mu$ A
$V_{OL}$ at 100 $\mu$ A Output Drive Current ( $V_{DD} = 1.25$ V)			0.20	Volts
Output Leakage Current			0.5	$\mu$ A
Frequency Response at 0.9V	30	40	60	Hz
Frequency Response at 1.4V	80	110	160	Hz
Frequency Response at 2.4V	120	260	375	Hz
Temperature Range of Operation <sup>(3)</sup>	-40		85	$^{\circ}$ C

## Absolute Maximum Ratings

Parameter	Rating	Units
Applied Magnetic Field	Unlimited <sup>(2)</sup>	Oersteds
Supply Voltage	5.5	Volts
Output Off Voltage	5.5	Volts
Output Current	200	$\mu$ A
Maximum Junction Temperature	+170	$^{\circ}$ C
Storage Temperature	-65 to +170	$^{\circ}$ C

### Notes:

- 1 Oe (Oersted) = 1 Gauss in air = 0.1 mT
2. Large magnetic fields WILL NOT damage NVE GMR sensors
3. Operation from  $-20^{\circ}$ C to  $-40^{\circ}$ C at supply voltages less than 1.0 V may not meet specifications.

**Typical Performance Characteristics**

**Average Supply Current vs. Supply Voltage, 25°C**

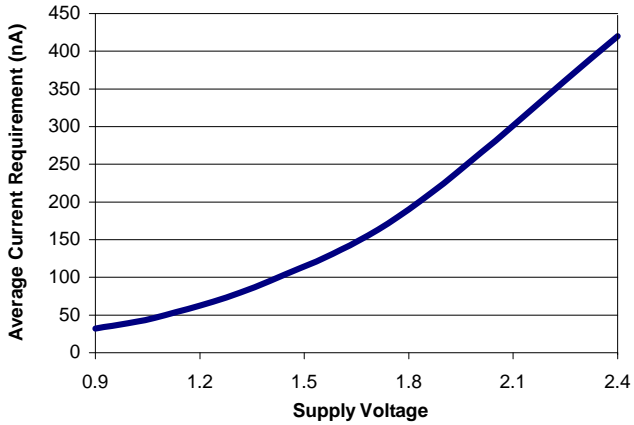

**Magnetic Operate Point vs. Voltage Supply, 25°C**

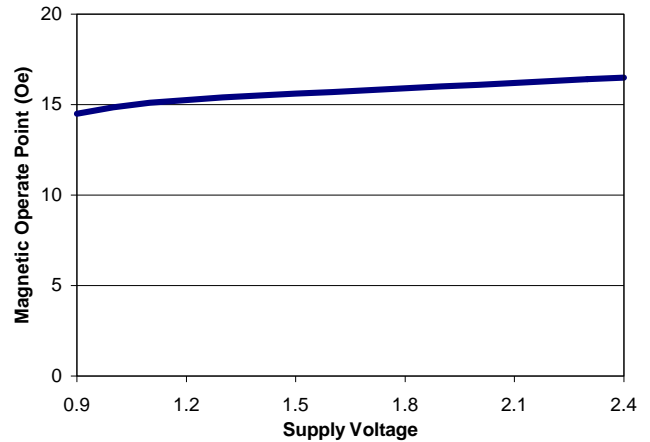

**Frequency Response vs. Supply Voltage, 25°C**

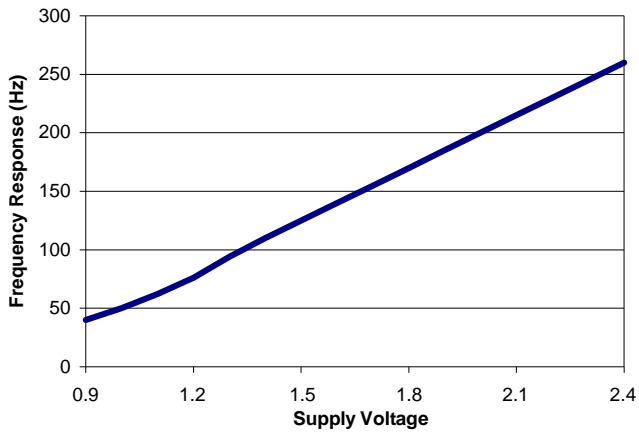

**Magnetic Operate Point vs. Temperature, 1.15V**

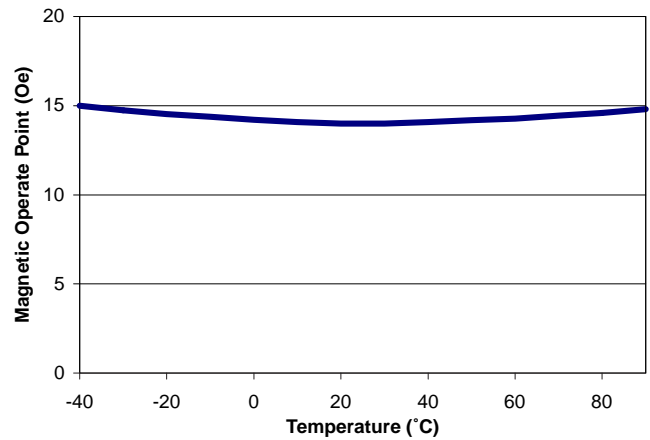

**Supply Voltage vs. Temperature Derating Curve**

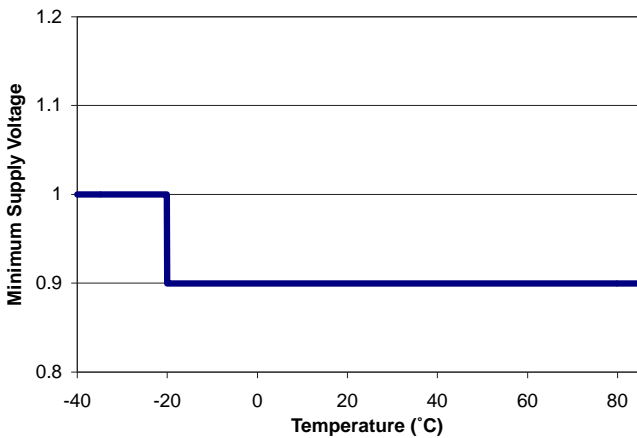

**Package Drawings, Dimensions, and Specifications:**

**4-Lead ULLGA Package**

1.1 mm x 1.1 mm x 0.40 mm; Lead Pitch 0.65 mm

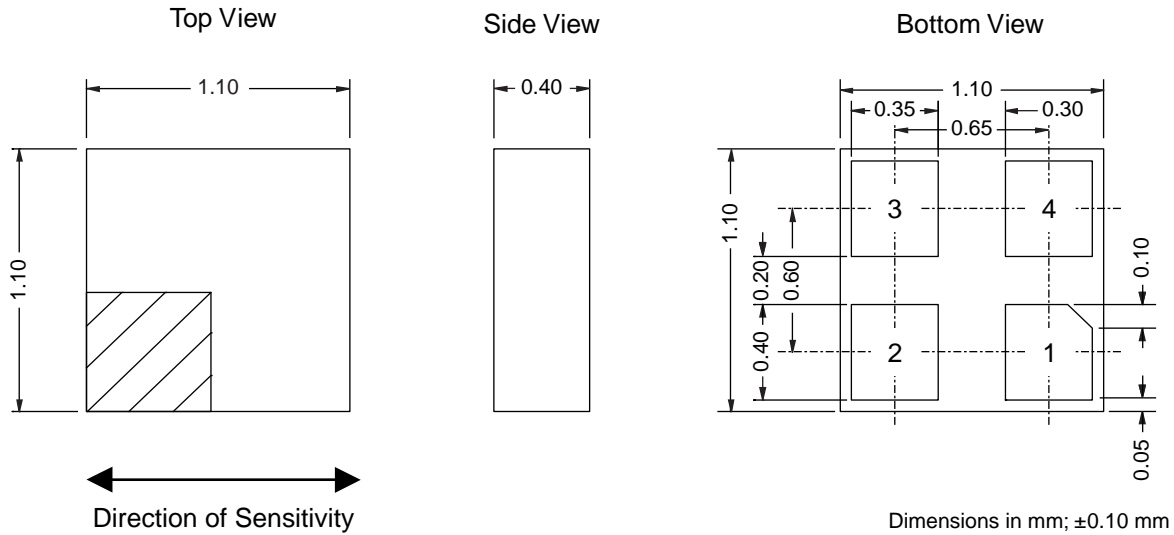

**Pinout:**

Pin 1	No Connect
Pin 2	V <sub>DD</sub>
Pin 3	Out
Pin 4	Ground

©NVE Corporation

All rights are reserved. Reproduction in whole or in part is prohibited without the prior written consent of the copyright owner.

SB-00-028

#### **Datasheet Limitations**

The information and data provided in datasheets shall define the specification of the product as agreed between NVE and its customer, unless NVE and customer have explicitly agreed otherwise in writing. All specifications are based on NVE test protocols. In no event however, shall an agreement be valid in which the NVE product is deemed to offer functions and qualities beyond those described in the datasheet.

#### **Limited Warranty and Liability**

Information in this document is believed to be accurate and reliable. However, NVE does not give any representations or warranties, expressed or implied, as to the accuracy or completeness of such information and shall have no liability for the consequences of use of such information.

In no event shall NVE be liable for any indirect, incidental, punitive, special or consequential damages (including, without limitation, lost profits, lost savings, business interruption, costs related to the removal or replacement of any products or rework charges) whether or not such damages are based on tort (including negligence), warranty, breach of contract or any other legal theory.

#### **Right to Make Changes**

NVE reserves the right to make changes to information published in this document including, without limitation, specifications and product descriptions at any time and without notice. This document supersedes and replaces all information supplied prior to its publication.

#### **Use in Life-Critical or Safety-Critical Applications**

Unless NVE and a customer explicitly agree otherwise in writing, NVE products are not designed, authorized or warranted to be suitable for use in life support, life-critical or safety-critical devices or equipment. NVE accepts no liability for inclusion or use of NVE products in such applications and such inclusion or use is at the customer's own risk. Should the customer use NVE products for such application whether authorized by NVE or not, the customer shall indemnify and hold NVE harmless against all claims and damages.

#### **Applications**

Applications described in this datasheet are illustrative only. NVE makes no representation or warranty that such applications will be suitable for the specified use without further testing or modification.

Customers are responsible for the design and operation of their applications and products using NVE products, and NVE accepts no liability for any assistance with applications or customer product design. It is customer's sole responsibility to determine whether the NVE product is suitable and fit for the customer's applications and products planned, as well as for the planned application and use of customer's third party customers. Customers should provide appropriate design and operating safeguards to minimize the risks associated with their applications and products.

NVE does not accept any liability related to any default, damage, costs or problem which is based on any weakness or default in the customer's applications or products, or the application or use by customer's third party customers. The customer is responsible for all necessary testing for the customer's applications and products using NVE products in order to avoid a default of the applications and the products or of the application or use by customer's third party customers. NVE accepts no liability in this respect.

#### **Limiting Values**

Stress above one or more limiting values (as defined in the Absolute Maximum Ratings System of IEC 60134) will cause permanent damage to the device. Limiting values are stress ratings only and operation of the device at these or any other conditions above those given in the recommended operating conditions of the datasheet is not warranted. Constant or repeated exposure to limiting values will permanently and irreversibly affect the quality and reliability of the device.

#### **Terms and Conditions of Sale**

In case an individual agreement is concluded only the terms and conditions of the respective agreement shall apply. NVE hereby expressly objects to applying the customer's general terms and conditions with regard to the purchase of NVE products by customer.

#### **No Offer to Sell or License**

Nothing in this document may be interpreted or construed as an offer to sell products that is open for acceptance or the grant, conveyance or implication of any license under any copyrights, patents or other industrial or intellectual property rights.

#### **Export Control**

This document as well as the items described herein may be subject to export control regulations. Export might require a prior authorization from national authorities.

#### **Automotive Qualified Products**

Unless the datasheet expressly states that a specific NVE product is automotive qualified, the product is not suitable for automotive use. It is neither qualified nor tested in accordance with automotive testing or application requirements. NVE accepts no liability for inclusion or use of non-automotive qualified products in automotive equipment or applications.

In the event that customer uses the product for design-in and use in automotive applications to automotive specifications and standards, customer (a) shall use the product without NVE's warranty of the product for such automotive applications, use and specifications, and (b) whenever customer uses the product for automotive applications beyond NVE's specifications such use shall be solely at customer's own risk, and (c) customer fully indemnifies NVE for any liability, damages or failed product claims resulting from customer design and use of the product for automotive applications beyond NVE's standard warranty and NVE's product specifications.